

AIR-TECH TWIST

USER MANUAL

For safe use, please always follow instructions.



■ Included Parts

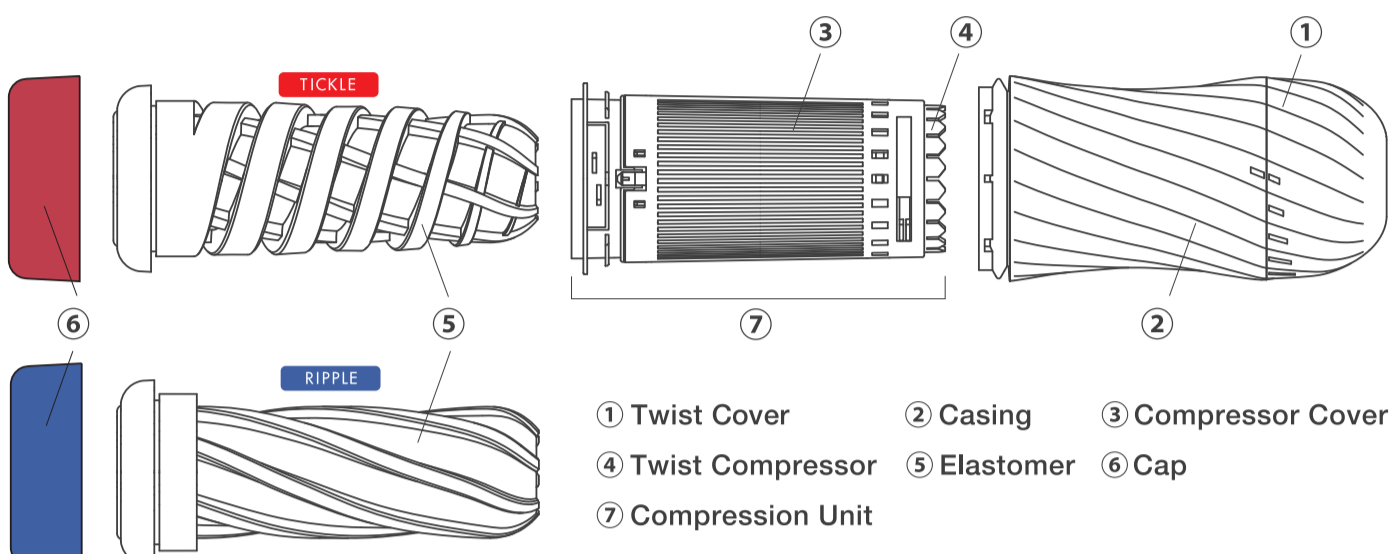

■ Tips and Troubleshooting

Removing Compression Unit

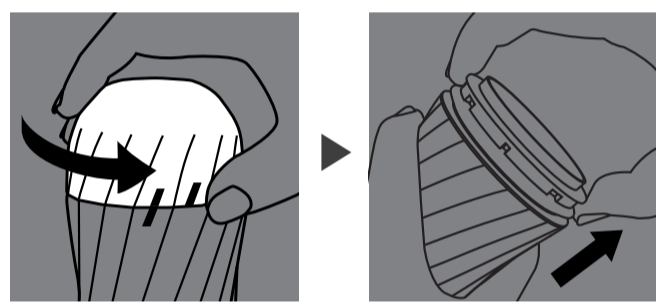

Return Twist Cover to original position.

Pull Compression Unit straight out.

Installing Compression Unit

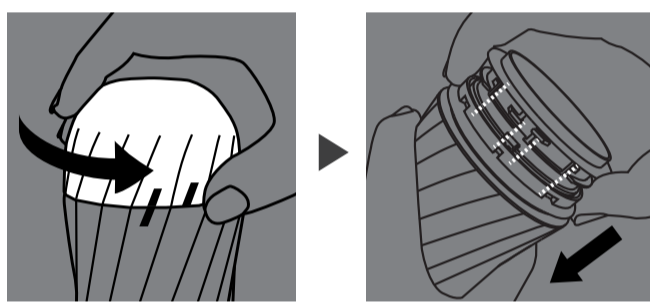

Ensure Twist Cover is in Original Position.

Install Compression Unit by inserting directly, all the way inside the Casing.

※ Installing Compression Unit with Twist Cover in any other position will damage product.

※ Incorrect installation may lead to product damage.

I can't remove the Compression Unit

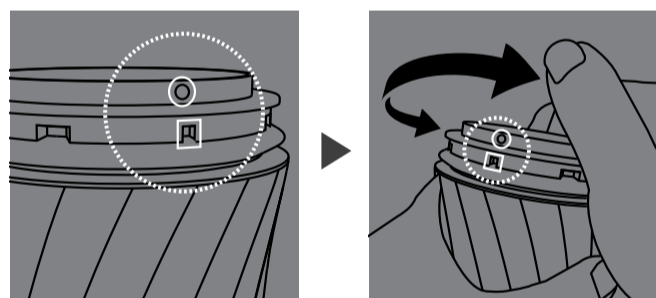

Remove Elastomer sleeve and ensure Compression Unit and Casing are in the position.

If in any other position, hold Casing as shown and twist only the Compression Unit, returning to the correct position.

※ Follow instructions above for "Removing Compression Unit".

The interior tightness and the tightness shown on the Twist Cover don't match.

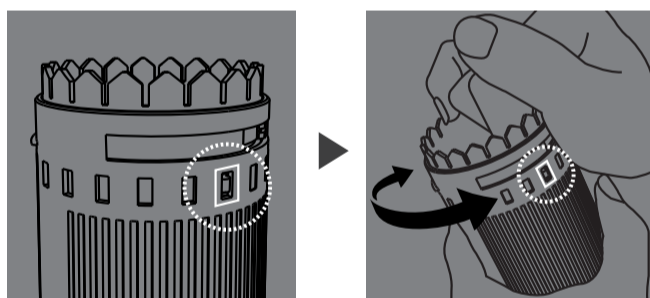

Remove Compression Unit and ensure the tab is in the right-most hole.

If not, hold Compressor Cover as shown and twist the Twist Compressor to bring the tab to the right-most hole.

※ Follow instructions above for "Installing Compression Unit".

Twisting the Twist Cover doesn't change the interior tightness.

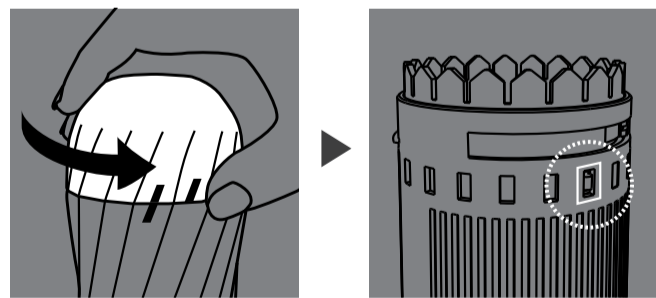

Ensure Twist Cover is in the original position.

Remove Compression Unit and ensure the tab is in the right-most hole.

※ Follow instructions above for "Installing Compression Unit" and ensure the Compression Unit is inserted all the way inside the Casing.

I've accidentally detached the Twist Cover from the Casing.

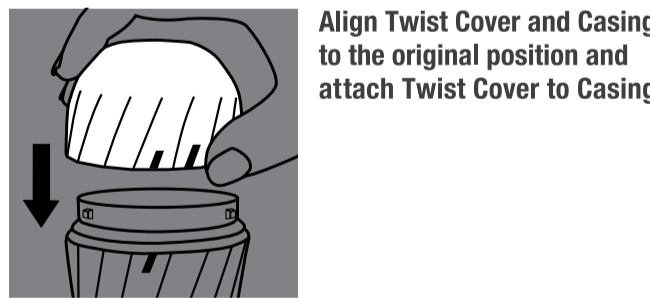

Align Twist Cover and Casing to the original position and attach Twist Cover to Casing.

■ Usage Warning

- Please remove air hole sticker located on top of product before use. ■ Lubricate insertion point and inside of Elastomer sleeve before use. ■ Adjust internal tightness by twisting the Twist Cover. ■ Before removing Elastomer sleeve, please return Twist Cover to original position (twist cover anticlockwise to the first setting.)
- Refrain from storing at any setting other than the original position. ■ After washing, pat dry with a soft cloth.
- Ensure product is dry before storing. ■ Do not detach Twist Cover from Casing. ■ Disassembling Compression Unit may lead to product damage, please do so at your own risk. ■ Do not use product without Compression Unit installed fully inside product. ■ Exposing product to strong forces (e.g.; dropping the item on a hard surface) or deforming any parts of the item may lead to the product breaking or not working as designed. TENGA Co., Ltd. can not provide after service for products broken due to fault of the user. ■ The enclosed lubricant is a one-time amount of TENGA HOLE LOTION REAL. ■ We recommend the TENGA brand lubricants for further use. ■ Silicone-based / oil-based lubricants / other oils such as massage oil or baby oil may cause damage to the product material.
- Male Pleasure Item ■ Always read instructions before use ■ Store in a cool, dry, dark place. ■ Keep away from children. ■ This is a novelty item. ■ TENGA Co., Ltd. can not be held liable if used in any way other than its intended use. ■ Do not share. ■ Do not use on damaged or irritated skin.