

FLIP ZERO

USER MANUAL English

Zeroing in on the Possibilities of Pleasure

TENGA has taken its unique FLIP Series to new heights of pleasure.

A seamless insertion point provides the perfect seal for no lubricant leakage and a strong vacuum made possible by a one-way valve.

The FLIP 0 (ZERO) features our most intricate internal details yet for great sensation, and our pioneering FLIP-open function keeps the item hygienic for multiple uses.

Parts

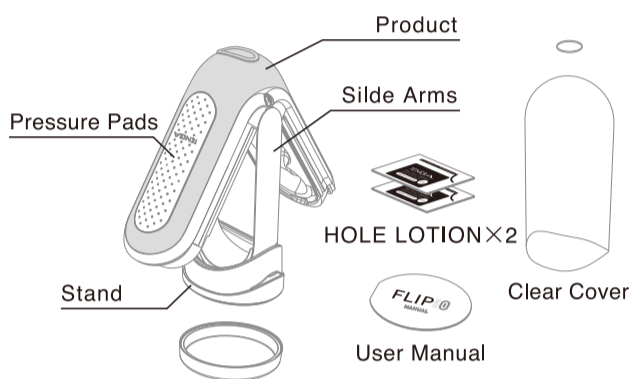

How to Open (1)

Remove Slide Arm

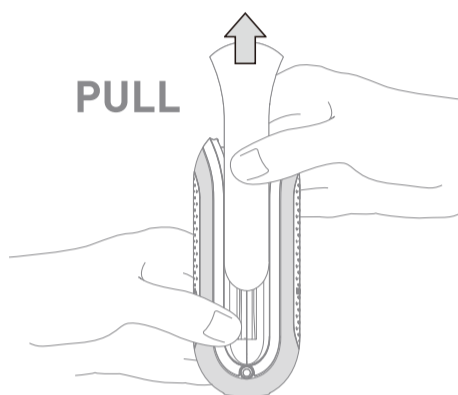

How to Open (2)

Squeeze Rails until lock clicks out of place.

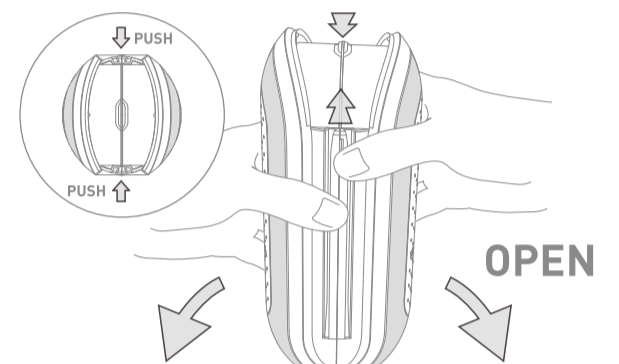

Before Use

Lubricate the interior of the FLIP ZERO. Close and lock into place with Slide Arms, and lubricate insertion point.

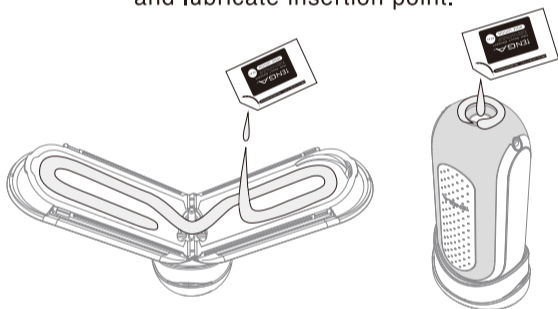

*We recommend TENGA Brand HOLE LOTION for further uses (sold separately.)

Using Pressure Pads

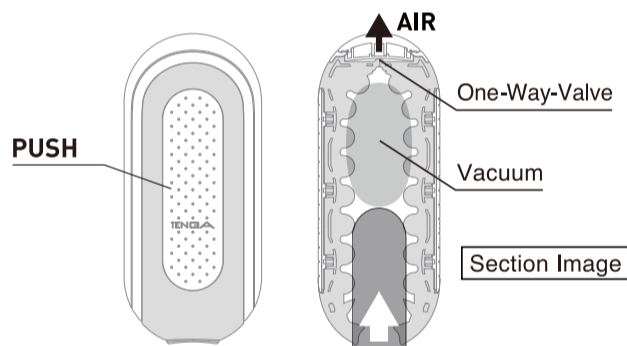

After insertion, you can squeeze the Pressure Pads at any point to provide focused stimulation and create an internal vacuum.

Internal Structure

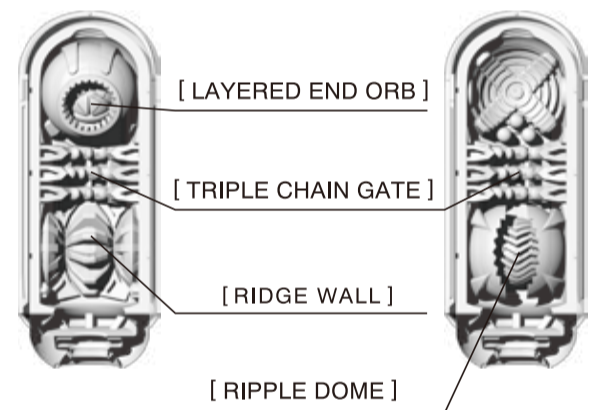

How to Dry

Remove Slide Arms and open Product. Wash thoroughly with warm water.

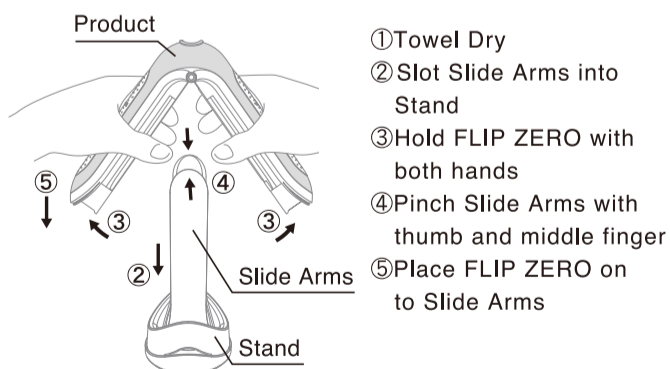

How to Store

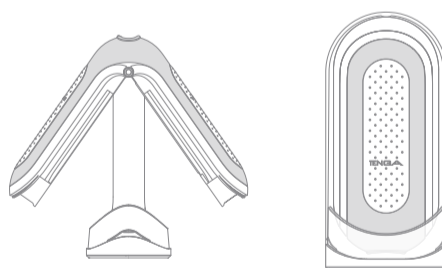

- ① Ensure product is fully dried.
- ② Place closed product onto Stand and cover with Clear Cover.
- ③ Store in a cool, dry, dark place away from direct sunlight.

Warning

Male Pleasure Item

Do not use on irritated or damaged skin.

Spot test on base of arm first to ensure no irritation occurs on skin contact. Contact medical professional should irritation occur.

Ensure product is fully washed and dried after use and before storage.

Use at room temperature.

Keep out of reach of children.

TENGA Co., Ltd. can not be held responsible if any parts are accidentally injured.

Do not intentionally damage product.

Do not share.

This is a novelty item. TENGA Co., Ltd. can not be held responsible for any other use than its intended use.

Use at own discretion.

Reusable. Do not use if damaged.

TENGA FLIP 0 (ZERO) TFZ-001

Materials: Elastomer / PC / GPPS / ABS / Silicone
Product Size 180x80x70mm / 480g

For further information visit: www.tenga-global.com

U.S. Patent 8,353,887 / Europe Patent 2168500 / Japan Patent 5261382
Design Patent Pending

Manufactured by TENGA Co., Ltd.

[TFZ01P02-10]